



USERS GUIDE

Connect Tech Inc.

Embedded Computing Experts

www.connecttech.com

Mini PCIe GPS Users Guide



Connect Tech Inc.

42 Arrow Road
Guelph, Ontario
N1K 1S6

www.connecttech.com

Tel: **519-836-1291**
Toll: **800-426-8979** (North America only)
Fax: 519-836-4878
Email: sales@connecttech.com
support@connecttech.com

Table of Contents

Table of Contents

Table of Contents.....	2
Preface.....	3
Disclaimer	3
Customer Support Overview	3
Contact Information	3
Limited Mini PCIe GPS Warranty	4
Copyright Notice	4
Trademark Acknowledgment	4
ESD Warning	5
Revision History	5
Introduction.....	6
Product Features and Specifications	6
Part Numbers / Ordering Information	6
Product Overview	7
Block Diagram	7
Connector Summary & Locations	7
Interface Pin-outs	8
Mini PCIe Edge Connector	8
External I/O Connector	9
Active Antenna Connector	10
Detailed Feature Description.....	11
USB	11
TIMEPULSE	11
W_DISABLE#	11
External Interrupt Input/WHEELTICK Input	11
FWD	11
External Battery.....	12
Local Battery and BAT_EN Header.....	12
On-board Indicator LEDs.....	12
Software Support for the NEO-7 and NEO-M8 GNSS Receivers	13
Cables.....	14
CBG162 – External I/O Cable.....	14
CBG163 – U.FL to SMA Female Cable.....	14

Preface

Disclaimer

The information contained within this user's guide, including but not limited to any product specification, is subject to change without notice.

Connect Tech assumes no liability for any damages incurred directly or indirectly from any technical or typographical errors or omissions contained herein or for discrepancies between the product and the user's guide.

Customer Support Overview

If you experience difficulties after reading the manual and/or using the product, contact the Connect Tech reseller from which you purchased the product. In most cases the reseller can help you with product installation and difficulties.

In the event that the reseller is unable to resolve your problem, our highly qualified support staff can assist you. Our support section is available 24 hours a day, 7 days a week on our website at: www.connecttech.com/sub/support/support.asp. See the contact information section below for more information on how to contact us directly. Our technical support is always free.

Contact Information

Mail/Courier

Connect Tech Inc.
Technical Support
42 Arrow Road
Guelph, Ontario
Canada N1K 1S6

Email/Internet

sales@connecttech.com
support@connecttech.com
www.connecttech.com

Note:

Please go to the [Download Zone](#) or the [Knowledge Database](#) in the [Support Center](#) on the Connect Tech website for product manuals, installation guides, device driver software and technical tips. Submit your technical support questions to our customer support engineers via the [Support Center](#) on the Connect Tech website.

Telephone/Facsimile

Technical Support representatives are ready to answer your call Monday through Friday, from 8:30 a.m. to 5:00 p.m. Eastern Standard Time. Our numbers for calls are:

Toll Free: 800-426-8979 (North America only)

Telephone: 519-836-1291 (Live assistance available 8:30 a.m. to 5:00 p.m. EST, Monday to Friday)

Facsimile: 519-836-4878 (on-line 24 hours)



Limited Mini PCIe GPS Warranty

Connect Tech Inc. provides a 2-Year Warranty for the Mini PCIe GPS. Should this product, in Connect Tech Inc.'s opinion, fail to be in good working order during the warranty period, Connect Tech Inc. will, at its option, repair or replace this product at no charge, provided that the product has not been subjected to abuse, misuse, accident, disaster or non-Connect Tech Inc. authorized modification or repair.

You may obtain warranty service by delivering this product to an authorized Connect Tech Inc. business partner or to Connect Tech Inc. along with proof of purchase. Product returned to Connect Tech Inc. must be pre-authorized by Connect Tech Inc. with an RMA (Return Material Authorization) number marked on the outside of the package and sent prepaid, insured and packaged for safe shipment. Connect Tech Inc. will return this product by prepaid ground shipment service.

The Connect Tech Inc. 2-Year Warranty is only valid over the serviceable life of the product. This is defined as the period during which all components are available. Should the product prove to be irreparable, Connect Tech Inc. reserves the right to substitute an equivalent product if available or to retract the 2-Year Warranty if no replacement is available.

The above warranty is the only warranty authorized by Connect Tech Inc. Under no circumstances will Connect Tech Inc. be liable in any way for any damages, including any lost profits, lost savings or other incidental or consequential damages arising out of the use of, or inability to use, such product.

Copyright Notice

The information contained in this document is subject to change without notice. Connect Tech Inc. shall not be liable for errors contained herein or for incidental consequential damages in connection with the furnishing, performance, or use of this material. This document contains proprietary information that is protected by copyright. All rights are reserved. No part of this document may be photocopied, reproduced, or translated to another language without the prior written consent of Connect Tech, Inc.

Copyright © 2020 by Connect Tech, Inc.

Trademark Acknowledgment

Connect Tech, Inc. acknowledges all trademarks, registered trademarks and/or copyrights referred to in this document as the property of their respective owners. Not listing all possible trademarks or copyright acknowledgments does not constitute a lack of acknowledgment to the rightful owners of the trademarks and copyrights mentioned in this document.

ESD Warning



Electronic components and circuits are sensitive to ElectroStatic Discharge (ESD). When handling any circuit board assemblies including Connect Tech COM Express carrier assemblies, it is recommended that ESD safety precautions be observed. ESD safe best practices include, but are not limited to:

- Leaving circuit boards in their antistatic packaging until they are ready to be installed.
- Using a grounded wrist strap when handling circuit boards, at a minimum you should touch a grounded metal object to dissipate any static charge that may be present on you.
- Only handling circuit boards in ESD safe areas, which may include ESD floor and table mats, wrist strap stations and ESD safe lab coats.
- Avoiding handling circuit boards in carpeted areas.
- Try to handle the board by the edges, avoiding contact with components.

Revision History

Revision	Date	Changes
0.00	2015-02-18	Document Created
0.01	2015-06-01	Updated to include MPG203/204 variants
0.02	2015-09-02	Updated to include MPG205 and MPG206, with ADR support
0.03	2016-03-02	Updated External IO Connector section to include as subsequent PCB revisions.
0.04	2016-03-17	Updated images
0.05	2016-11-08	Added MPG207 and MPG208 variants
0.06	2017-01-26	Fixed typo in pinout section
0.07	2020-06-08	Added MPG209 and MPG210 variants

Introduction

Connect Tech's Mini PCIe GPS is a ruggedized GPS module base on the very small industry standard Mini PCIe "Full" module format.

Using the USB bus, this Mini PCIe GPS provides global positioning and time-stamp information, while taking up little space and power within a system. Also considering the existing support for Windows and Linux, the Mini PCIe GPS can be easily integrated into any existing system, as well as easily implemented into new systems.

Product Features and Specifications

Specifications	
Dimensions	50.95 mm x 30 mm, Mini PCIe "Full" form factor
Antenna Connector	U.FL, support for active antennas only
GPS	GPS, GLONASS, QZSS, Galileo UBX, RTCM, NMEA protocols
I/O	TIMPULSE output synchronized with GPS time grid WHEELTICK input (used for Automotive Dead Reckoning) FWD input (used for Automotive Dead Reckoning) External Interrupt Input External Battery Input
Cables	CBG162: External I/O Cable CBG163: R.FL to SMA Female Cable
Antenna	GPS-06T, VTGPISA-9, Active GPS/GLONASS antennas only
Environmental	-40° C to +85° C
Warranty and Support	2 Years

Part Numbers / Ordering Information

Ordering Information	
MPG201	Mini PCIe GPS Receiver (Battery not included) populated with NEO-7N module
MPG202	Mini PCIe GPS Receiver (Battery included) populated with NEO-7N module
MPG203	Mini PCIe GPS Receiver (Battery not included) populated with NEO-M8N module
MPG204	Mini PCIe GPS Receiver (Battery included) populated with NEO-M8N module
MPG205	Mini PCIe GPS Receiver (Battery not included) populated with NEO-M8L module, supports Automotive Dead Reckoning
MPG206	Mini PCIe GPS Receiver (Battery included) populated with NEO-M8L module, supports Automotive Dead Reckoning
MPG207	Mini PCIe GPS Receiver (Battery not included) populated with NEO-M8U module, supports Untethered Dead Reckoning
MPG208	Mini PCIe GPS Receiver (Battery included) populated with NEO-M8U module, supports Untethered Dead Reckoning
MPG209	Mini PCIe GPS Receiver (Battery not included) populated with NEO-M9N
MPG210	Mini PCIe GPS Receiver (Battery included) populated with NEO-M9N

Product Overview

Block Diagram

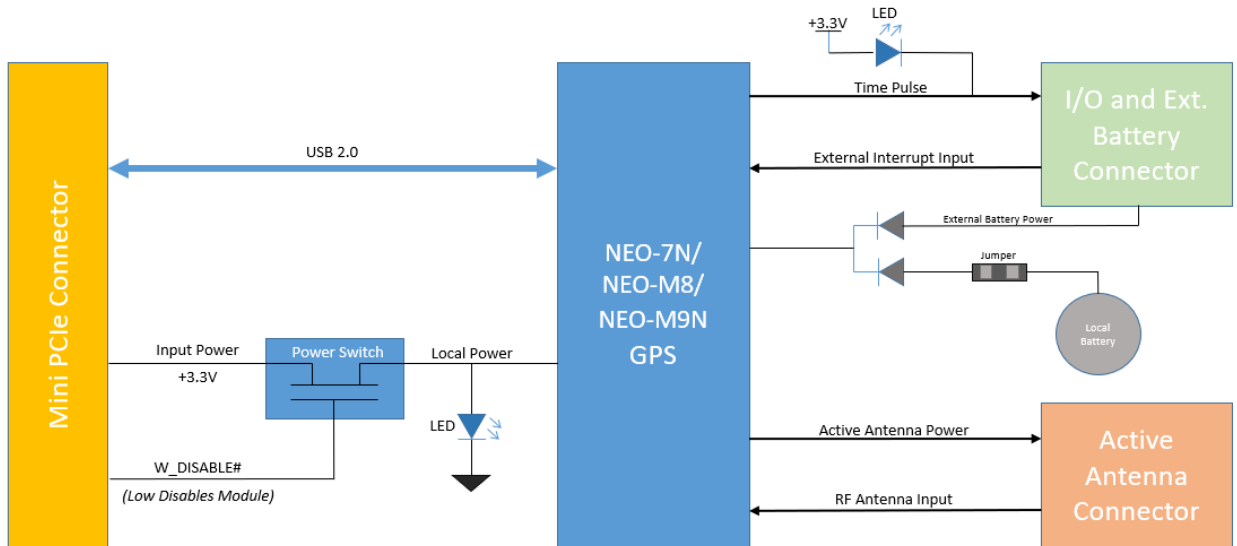

Connector Summary & Locations

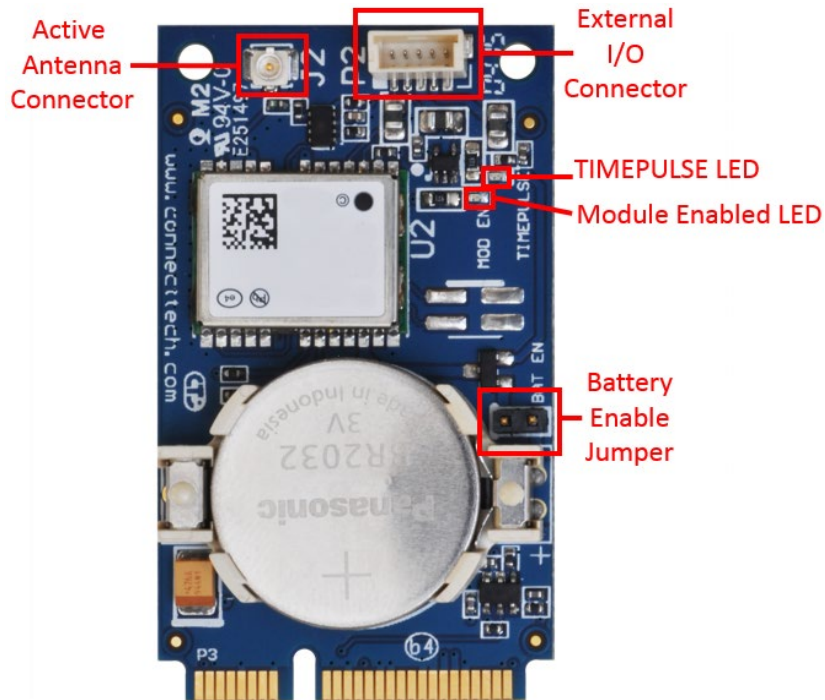

Interface Pin-outs

Mini PCIe Edge Connector

The Mini PCIe GPS pin-out is compliant to the PCI Express Mini Card Electromechanical Specification Rev. 2.0. Please note that this module does not require the +1.5V power provided to a standard Mini PCIe connector. This module uses only +3.3V for input power. This module does not connect the Display Port or PCIe pins on the Mini PCIe connector.

Function	Mini PCIe Card Edge Connector			
Location	P3			
Pinout	Signal	Pin	Pin	Signal
	NC	1	2	+3.3V
NC	3	4	GND	
NC	5	6	NC	
NC	7	8	NC	
GND	9	10	NC	
NC	11	12	NC	
NC	13	14	NC	
GND	15	16	NC	
NC	17	18	GND	
NC	19	20	W_DISABLE#	
GND	21	22	RESET#	
NC	23	24	+3.3V	
NC	25	26	GND	
GND	27	28	NC	
GND	29	30	NC	
NC	31	32	NC	
NC	33	34	GND	
GND	35	36	USB_DP-	
GND	37	38	USB_DP+	
+3.3V	39	40	GND	
+3.3V	41	42	NC	
GND	43	44	NC	
NC	45	46	NC	
NC	47	48	NC	
NC	49	50	GND	
NC	51	52	+3.3V	



External I/O Connector

The pinout for the I/O connector is different between revision A and all subsequent revisions (B, C, etc.) of the PCB. Please see the tables below that indicate the pinouts for each PCB revision.

To determine the PCB revision of the board you have, please see the underside of the board:

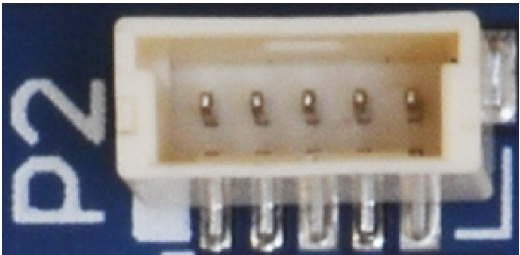

Revision A I/O Connector Pin-out

Function	External I/O Connector			 501331-0507																	
Location	P2																				
Connector PN	501331-0507 - Manufacturer: Molex																				
Mating Connector PN	501330-0500 - Manufacturer: Molex CTI Cable #: CBG162																				
Pinout	<table border="1"> <thead> <tr> <th>Pin</th> <th>Signal</th> <th>Description</th> </tr> </thead> <tbody> <tr> <td>1</td> <td>EXT_INT</td> <td>External Interrupt Input</td> </tr> <tr> <td>2</td> <td>TIMEPULSE</td> <td>Time pulse Output</td> </tr> <tr> <td>3</td> <td>GND</td> <td>Digital Ground</td> </tr> <tr> <td>4</td> <td>EXT_BAT</td> <td>External Battery Input</td> </tr> <tr> <td>5</td> <td>GND</td> <td>Digital Ground</td> </tr> </tbody> </table>	Pin	Signal		Description	1	EXT_INT	External Interrupt Input	2	TIMEPULSE	Time pulse Output	3	GND	Digital Ground	4	EXT_BAT	External Battery Input	5	GND	Digital Ground	
Pin	Signal	Description																			
1	EXT_INT	External Interrupt Input																			
2	TIMEPULSE	Time pulse Output																			
3	GND	Digital Ground																			
4	EXT_BAT	External Battery Input																			
5	GND	Digital Ground																			

Subsequent Revisions (rev B, C, etc.) I/O Connector Pin-out

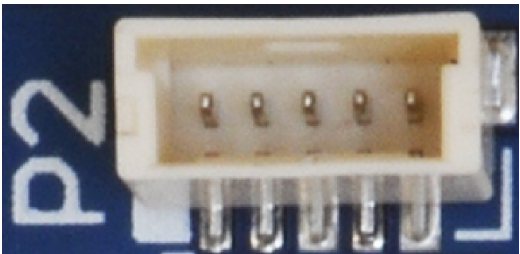
Function	External I/O Connector			 501331-0507																	
Location	P2																				
Connector PN	501331-0507 - Manufacturer: Molex																				
Mating Connector PN	501330-0500 - Manufacturer: Molex CTI Cable #: CBG162																				
Pinout	<table border="1"> <thead> <tr> <th>Pin</th> <th>Signal</th> <th>Description</th> </tr> </thead> <tbody> <tr> <td>1</td> <td>EXT_INT / WHEELTICK</td> <td>External Interrupt Input or Speed pulse input</td> </tr> <tr> <td>2</td> <td>TIMEPULSE</td> <td>Time pulse Output</td> </tr> <tr> <td>3</td> <td>FWD</td> <td>Forward/Reverse indicator</td> </tr> <tr> <td>4</td> <td>GND</td> <td>Digital Ground</td> </tr> <tr> <td>5</td> <td>EXT_BAT</td> <td>External Battery Input</td> </tr> </tbody> </table>	Pin	Signal		Description	1	EXT_INT / WHEELTICK	External Interrupt Input or Speed pulse input	2	TIMEPULSE	Time pulse Output	3	FWD	Forward/Reverse indicator	4	GND	Digital Ground	5	EXT_BAT	External Battery Input	
Pin	Signal	Description																			
1	EXT_INT / WHEELTICK	External Interrupt Input or Speed pulse input																			
2	TIMEPULSE	Time pulse Output																			
3	FWD	Forward/Reverse indicator																			
4	GND	Digital Ground																			
5	EXT_BAT	External Battery Input																			

NOTE: WHEELTICK is only available on MPG205 and MPG206, otherwise this signal is EXT_INT

NOTE: FWD is only available on MPG205 and MPG206, otherwise it is not connected and should be left floating

Active Antenna Connector

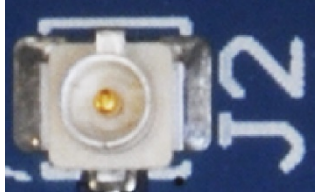
Function	Active Antenna Connector	
Location	J2	
Connector PN	U.FL-R-SMT-1(01) - Manufacturer: Hirose	
Mating Connector PN	R.FL Socket Standard CTI Cable #: CBG163	

U.FL Jack

Detailed Feature Description

USB

The Mini PCIe GPS uses a USB 2.0 Full Speed (12Mb/s) interface as the primary communication bus. The USB interfaces is connect between the GPS receiver and the Mini PCIe card edge connector (pins 36/38).

TIMEPULSE

The TIMEPULSE output is a buffered and ESD protected signal from the GPS receiver. This signal connects to pin 2 of the External I/O Connector. It also drives the TIMEPULSE LED. By default, when satellites are not fixed this signal is High (3.3V). When satellites are fixed, this signal pulses at 1 pulse-per-second (1Hz) with a 20% duty cycle (200ms High, 800ms Low). For more information see the Receiver Description Including Protocol Specification document for your GPS receiver found in the Software Support section of this document.

W_DISABLE#

The W_DISABLE# input from the Mini PCIe card edge connector (pin 20) can be used to enable and disable power to the Mini PCIe GPS module. When W_DISABLE# is low, the module is disabled and no power is applied to the Mini PCIe GPS. When W_DISABLE# is High, the module is enabled and powered on. This signal is locally pulled up to 3.3V through a 10K ohm resistor.

External Interrupt Input/WHEELTICK Input

The external interrupt/WHEELTICK input is an ESD protected input signal from the external I/O connector to the GPS receiver. On modules that do not support Automotive Dead Reckoning, this signal will always be an External Interrupt input, and this input can be used for control of the GPS receiver or for aiding. On modules that support Automotive Dead Reckoning (MPG205/MPG206), this signal is by default used as the WHEELTICK input and is used to provide speed pulse information to the module. If the speed pulse information is available from the host processor, then the information can be provided using software messages in the UBX protocol. If using software messages to provide speed pulse information, this signal can be configured as an external interrupt input. See the Receiver Description Including Protocol Specification document for your GPS receiver found in the Software Support section of this document. If this signal is not used, it should be left floating. Do not exceed 3.6V on this signal.

FWD

The forward/reverse signal is an ESD protected input used on modules that support Automotive Dead Reckoning. This signal is used to indicate the moving direction of the module. An active high indicates moving forward and a low for moving backwards. If the forward/reverse information is available from a host processor, then this information can be provided to the module using software messages in the UBX protocol. For more information see the Receiver Description Including Protocol Specification document for your GPS receiver found in the Software Support section of this document. On modules that do not support Automotive Dead Reckoning, this signal should be left floating. Do not exceed 3.6V on this signal.

External Battery

The external battery input in an ESD protected input from the External I/O Connector to the backup voltage supply of the GPS receiver. The purpose of a battery signal is to power internal memory for GPS almanac, ephemeris, and last position retention through power cycles. The voltage on this input signal should be greater than 2.0V and less than 3.6V. The supply of this signal should be able to provide at least 15uA continuous at room temperature, and 24uA at +85 degrees Celsius.

Local Battery and BAT_EN Header

There is a local battery supply on the Mini PCIe GPS. The purpose of a battery signal is to power internal memory for GPS almanac, ephemeris, and last position retention through power cycles. The design includes a BR2032 battery as well as a battery enable header. When a jumper is installed the BAT_EN header, the local battery is connected to the receivers back-up supply. When the jumper is not installed, the local battery is not connected to anything. When both a BR2032 battery as well as the BAT_EN jumper is installed, the GPS receiver will typically consumer 15uA on its battery supply input at room temperature and 24uA at 85 degrees Celsius. You can estimate the expected battery life with the following equation:

$$\text{Battery Life (yrs)} = 30 / [15 + (T_{\text{avg}} - 25) \times 0.15]$$

where: T_{avg} = the average ambient temperature in degrees Celsius
0.15 = the typically battery supply current consumption at 25 degrees Celsius

On-board Indicator LEDs

LED	Description
TIMEPULSE	TIMEPULSE visual indicator. This LED will blink at the rate and duty cycle of the TIMEPULSE output.
MOD EN	ON: indicates the module is powered on and enabled OFF: indicated the module is not powered and is disabled *the module is enabled/disabled using the W_DISABLE# input from the Mini PCIe card edge connector



Software Support for the NEO-7 and NEO-M8 GNSS Receivers

For configuration and setting options for the NEO GNSS receivers, including drivers, protocol descriptions and u-Blox powerful u-center application please refer to the Product Resources found on the u-Blox website:

<https://www.u-blox.com/en/product-resources>

Cables

CBG162 – External I/O Cable

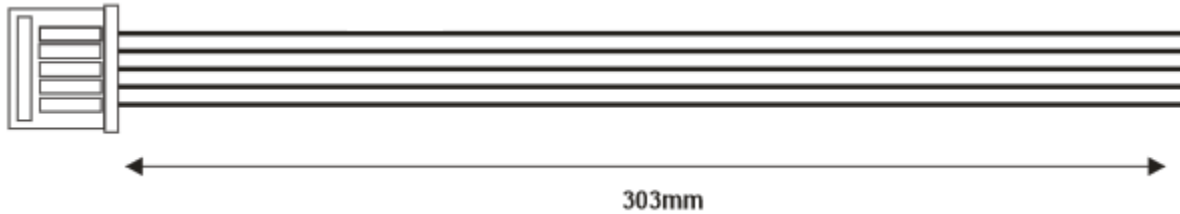

501330-0500	Signal	Open End (Unterminated)
1	See I/O Connector Section for pin-out	Un-terminated
2		Un-terminated
3		Un-terminated
4		Un-terminated
5		Un-terminated

CBG163 – U.FL to SMA Female Cable



SMA Female (Socket)	TO	U.FL
---------------------	----	------